

Roman Arch

You will need to cast the temple mold (#62) nine times and the prison tower mold (#60) eight times to build the arch.

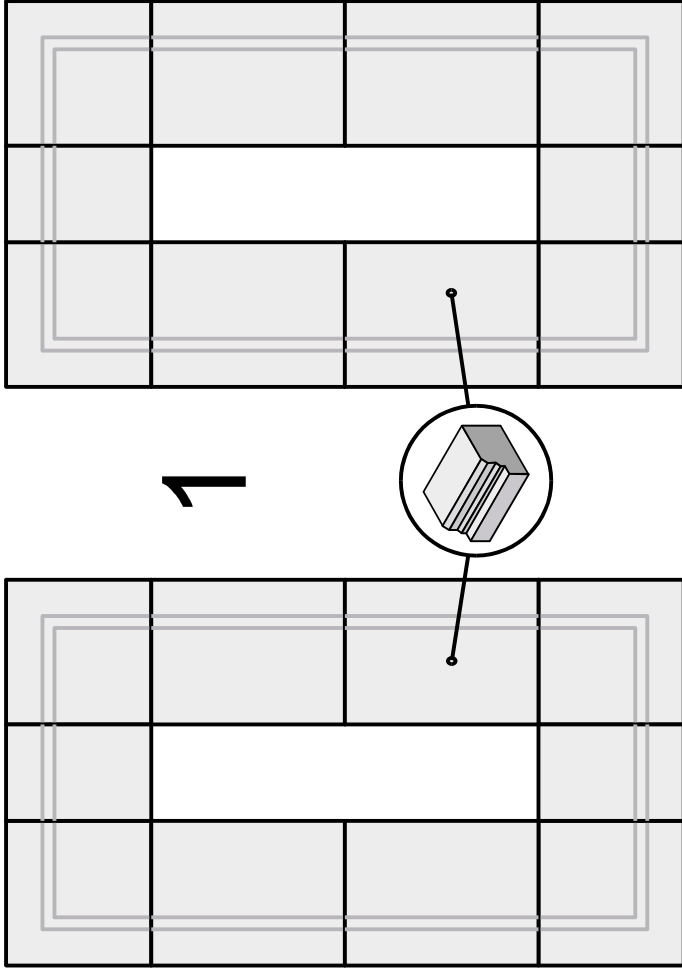

Steps 1 - 3 use the Roman Temple mold.

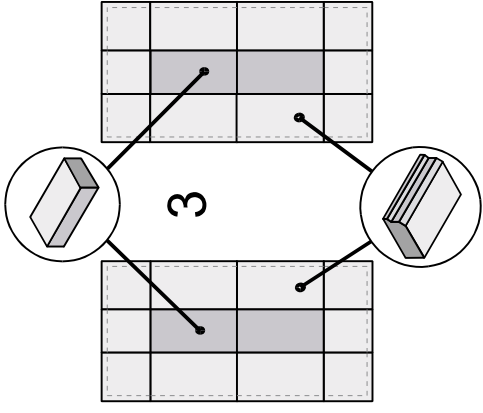
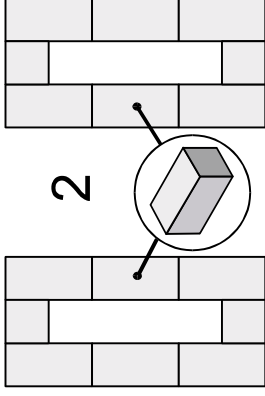

Steps 4 - 10 use the Prison Tower mold (except for the pillars).

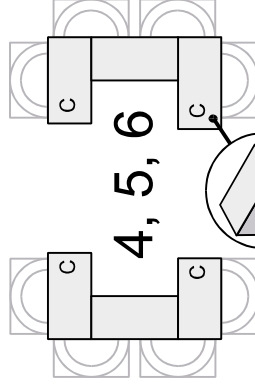

C - Refers to blocks with the brick decoration on the corners.

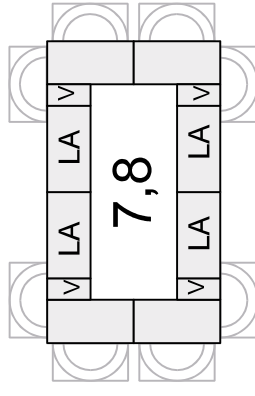

V - Refers to the textured floor tile block turned **Vertically** to span 2 rows
 LA - Refers to the **Large Arch**

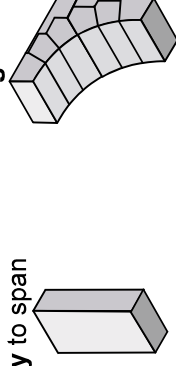

Add pillars onto the sides after the step 10 is complete.

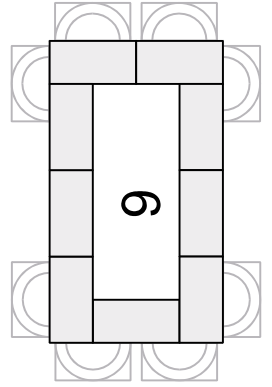

Steps 11 & 12 use the Roman Temple mold.

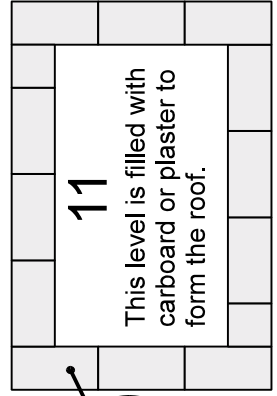

11
 This level is filled with carboard or plaster to form the roof.

