

Cathedral Building Instructions

Please note that this is a fairly difficult and time consuming project. I suggest building one or two more basic models before you try to tackle this one.

You will need four molds to complete this project.

Mold #100 (or #50 or #51) Basic Blocks - **Cast this mold 30 times.** 

Mold #54 Gothic Church - **Cast this mold 18 times.**

Mold #55 Bell Tower - **Cast this mold 21 times.**

Mold # 56 Tomb Mold - **Cast this mold 18 times.**

When finished, sort and count the blocks. You will find that **several blocks will need additional casts** to finish the completed number (especcailly the roof tiles).

Each piece of the cathedral is identified with a letter. Below is a floor plan showing where each of these lettered pieces go.

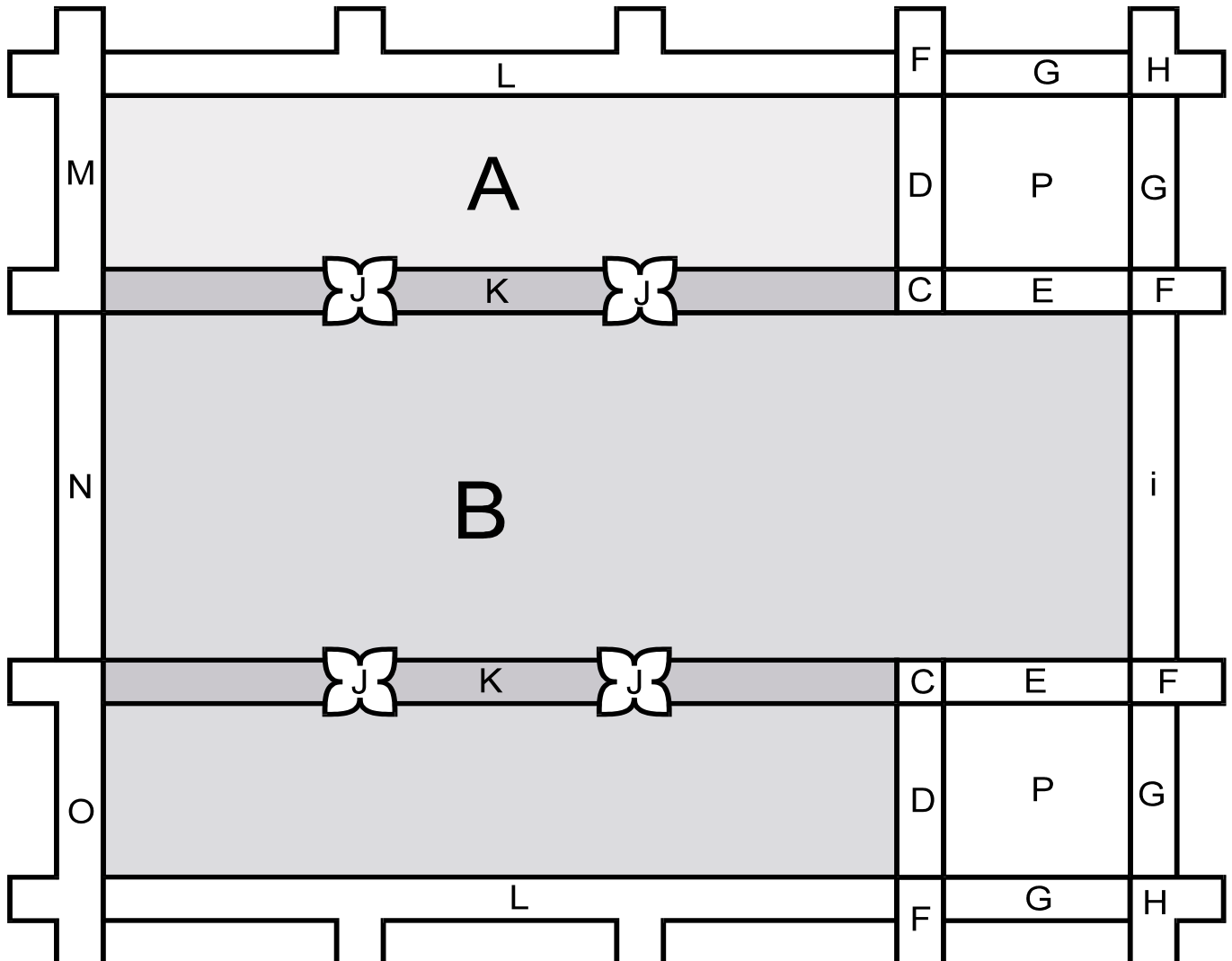

Cathedral Parts List

For ease of use, the **curved arches** are drawn in a **flat view** and actual size for easy matching. Many of the same pieces appear on more than one mold

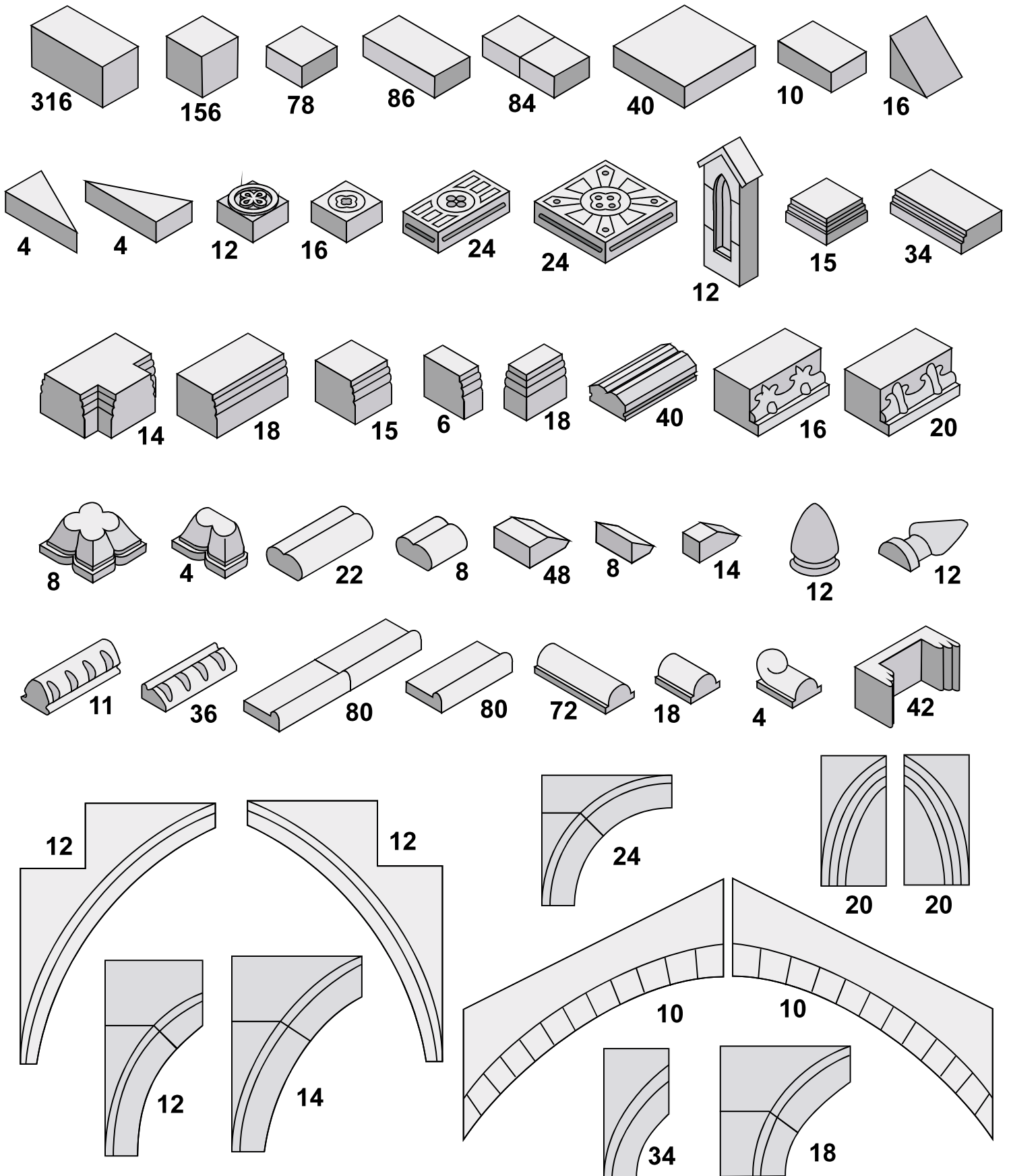

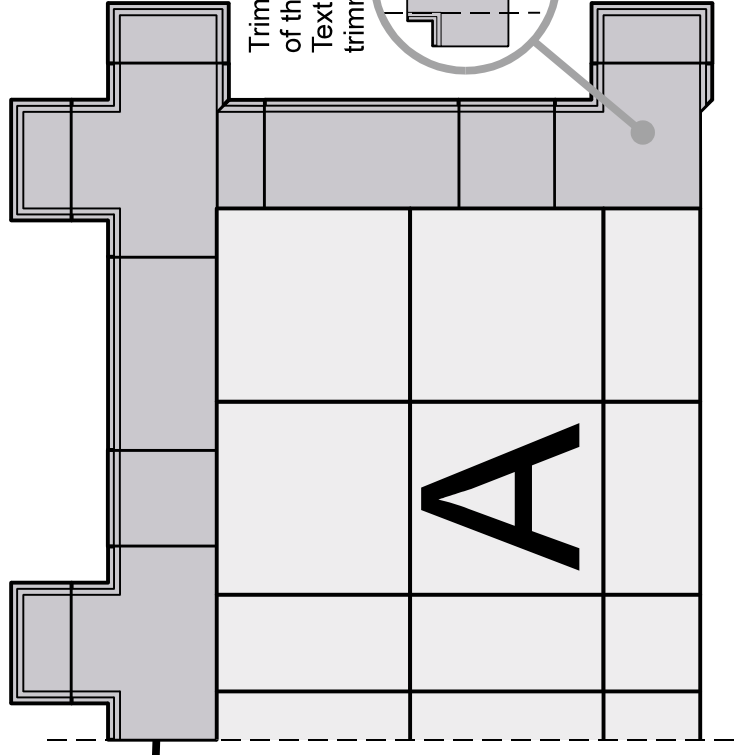
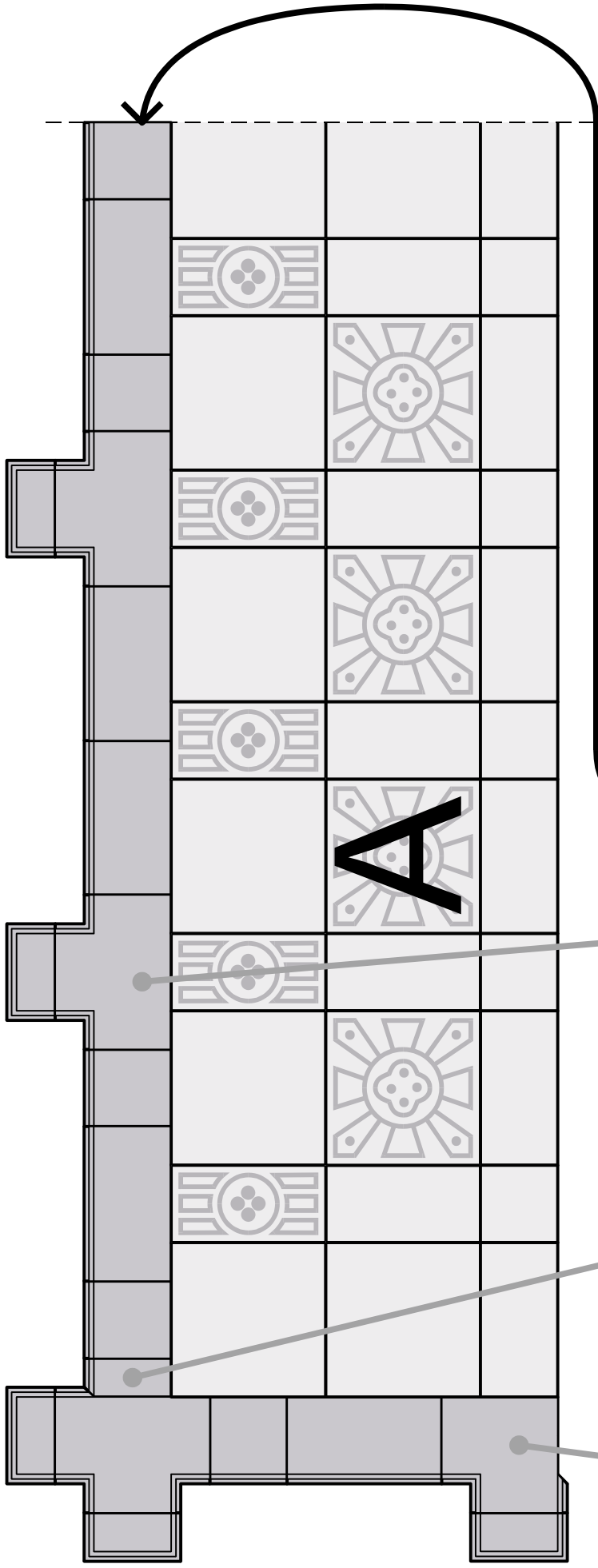

Trim the left side of this piece. Texture the trimmed side.

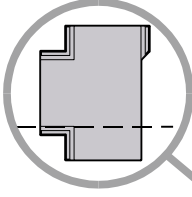

A

A



Several blocks you will have to miter the edges at 45 deg.

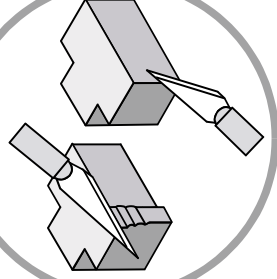

For these sections, trim off the decorative edge as shown. Using a hobby knife, chip away at the smooth surface to texture it.

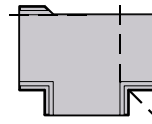

Trim the sides shown. Be sure to miter the inside corner.

The Cathedral

Connect Floorplan

Connect Floorplan

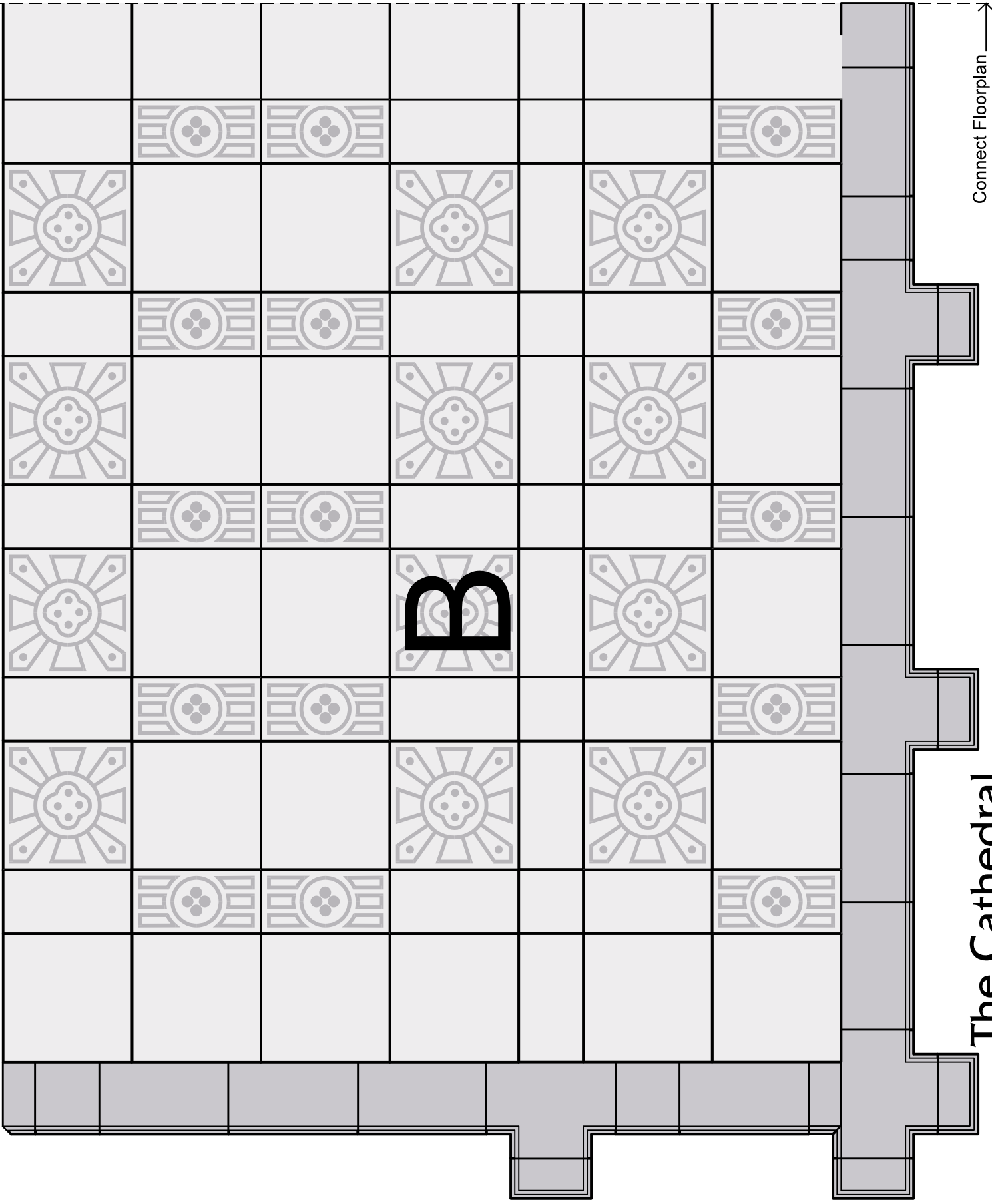

The Cathedral

The Cathedral

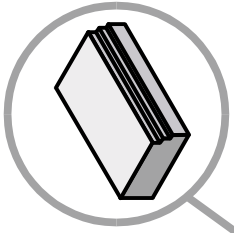

The three lighter blocks shown are of this type

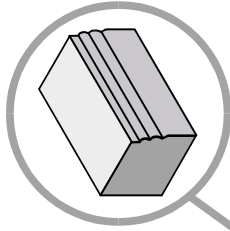

The remaining darker blocks are the base pieces

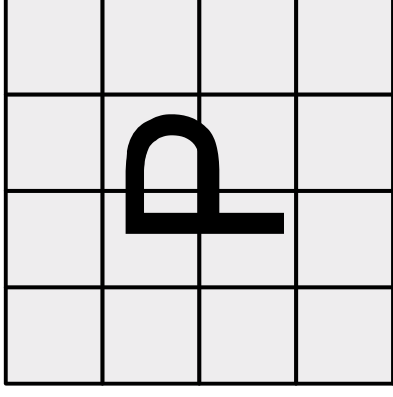
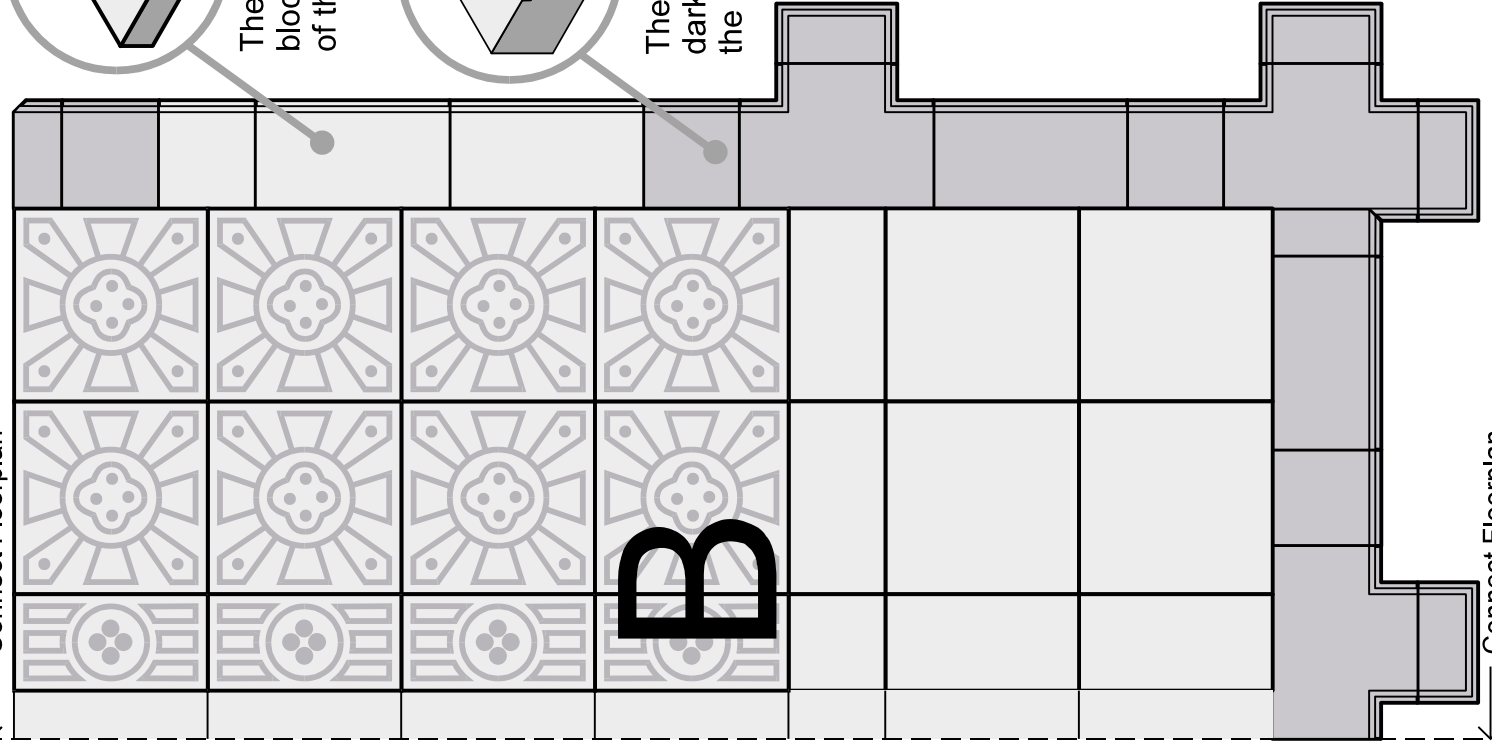

Bell tower top floors.
Make one copy of each.

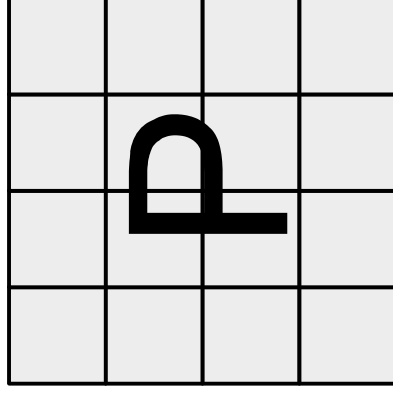

Assemble and glue four pillars together.

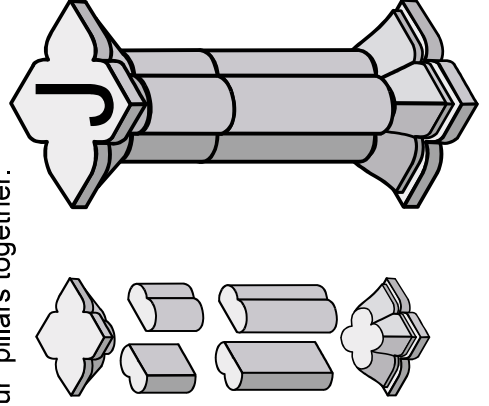

The Cathedral

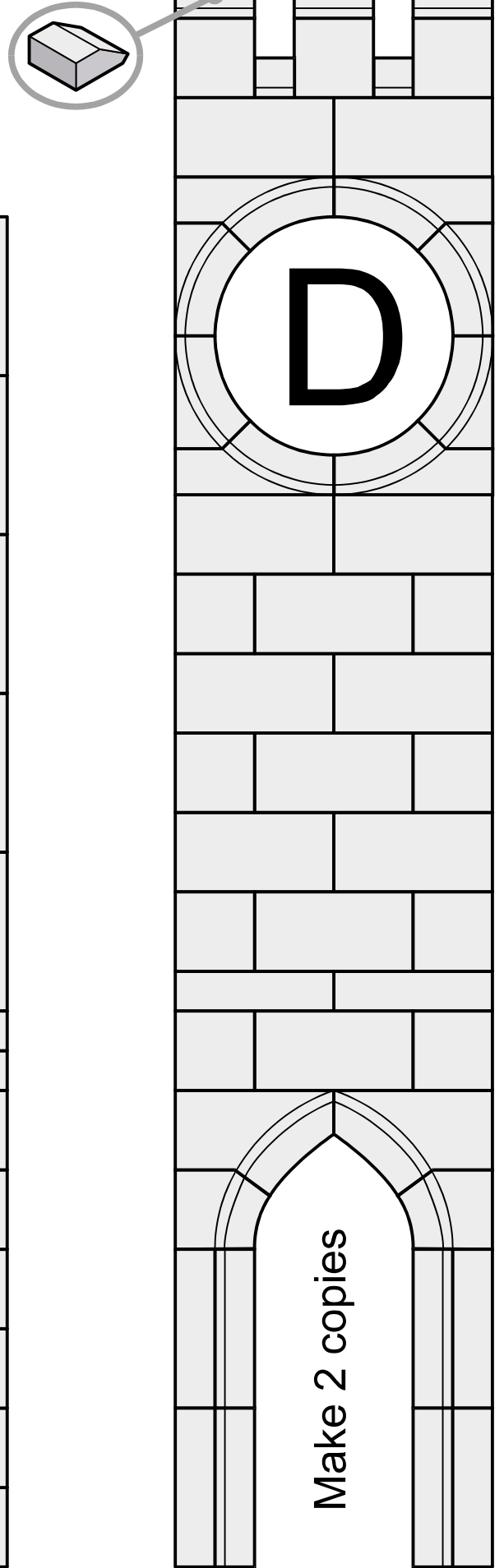
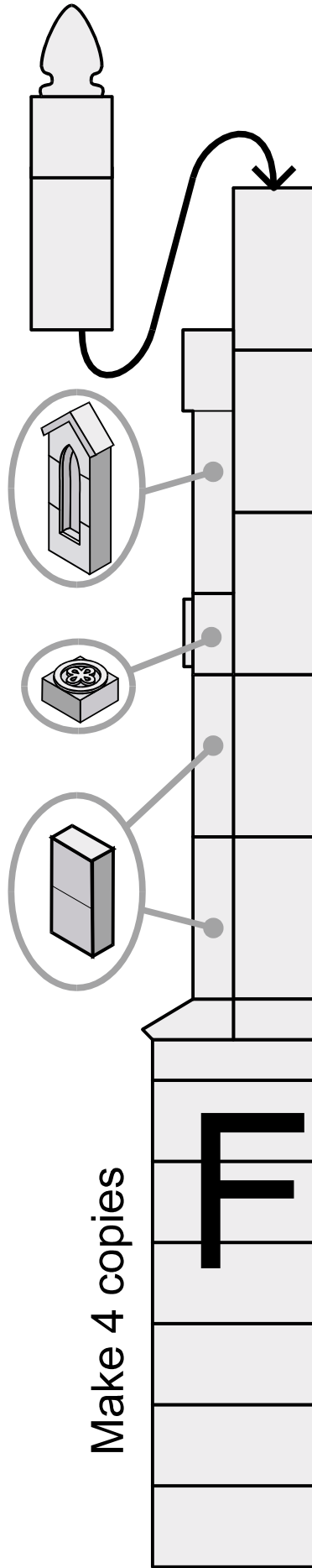
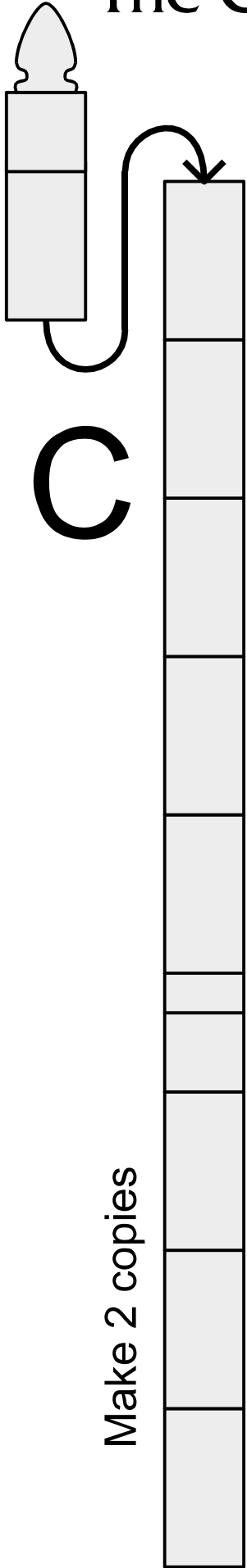

The Cathedral

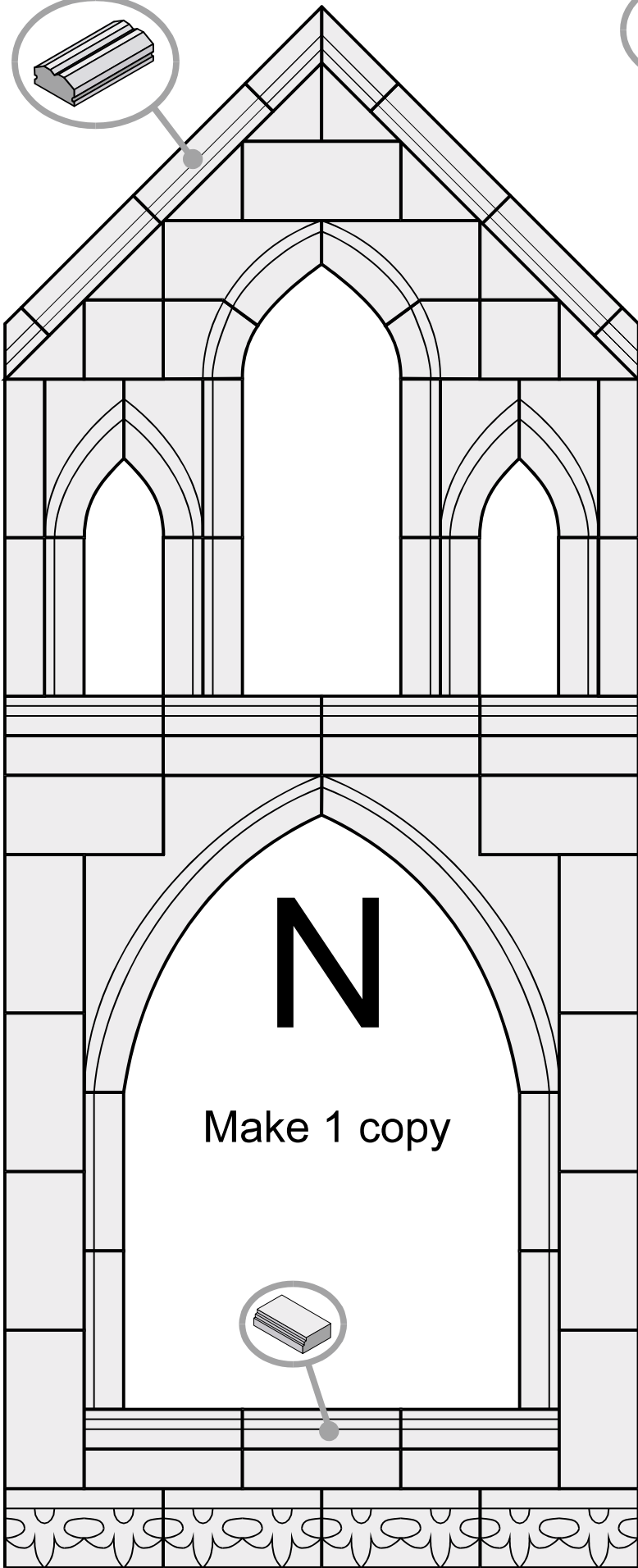
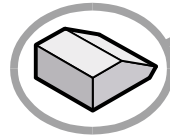
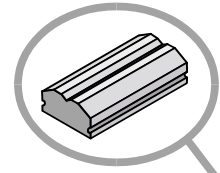

Make 1 copy

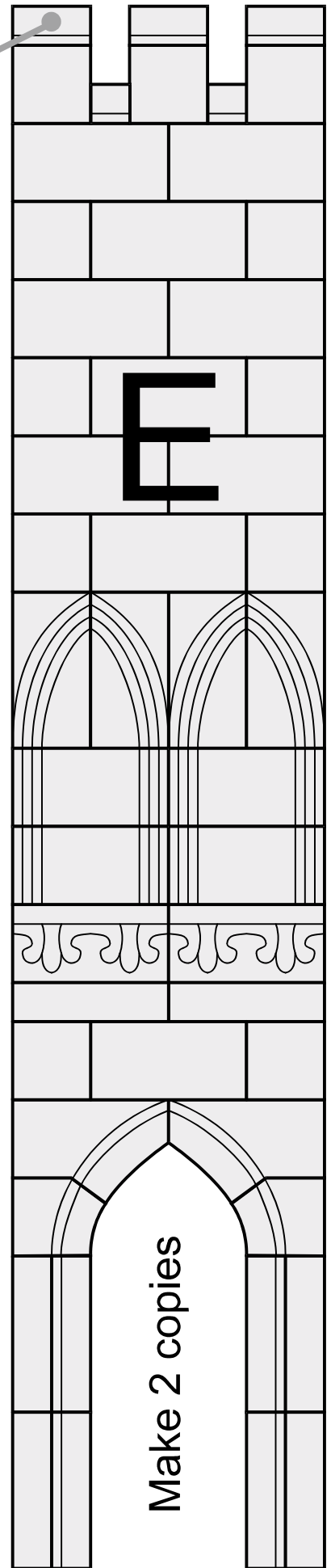

Make 2 copies

The Cathedral

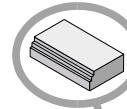
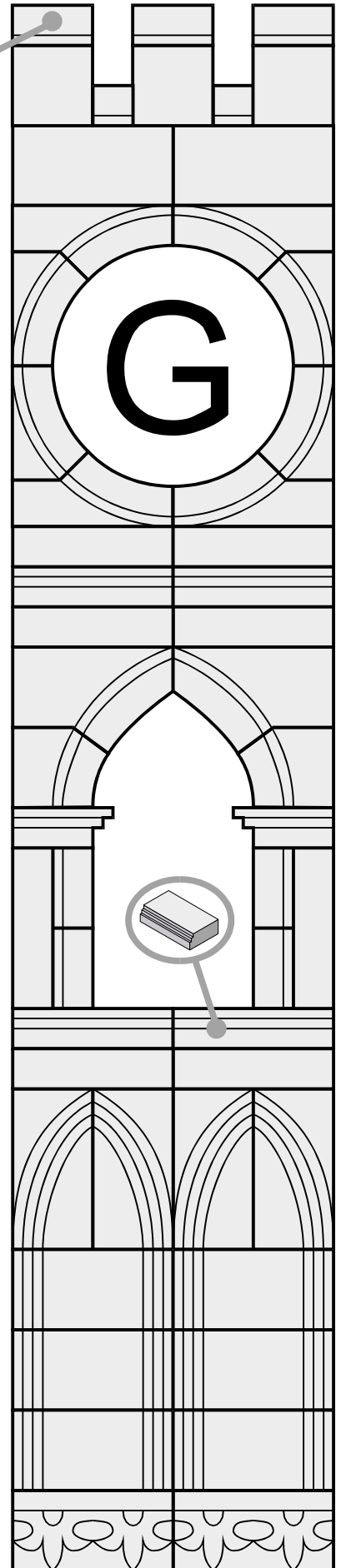
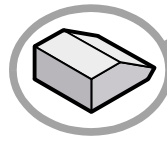
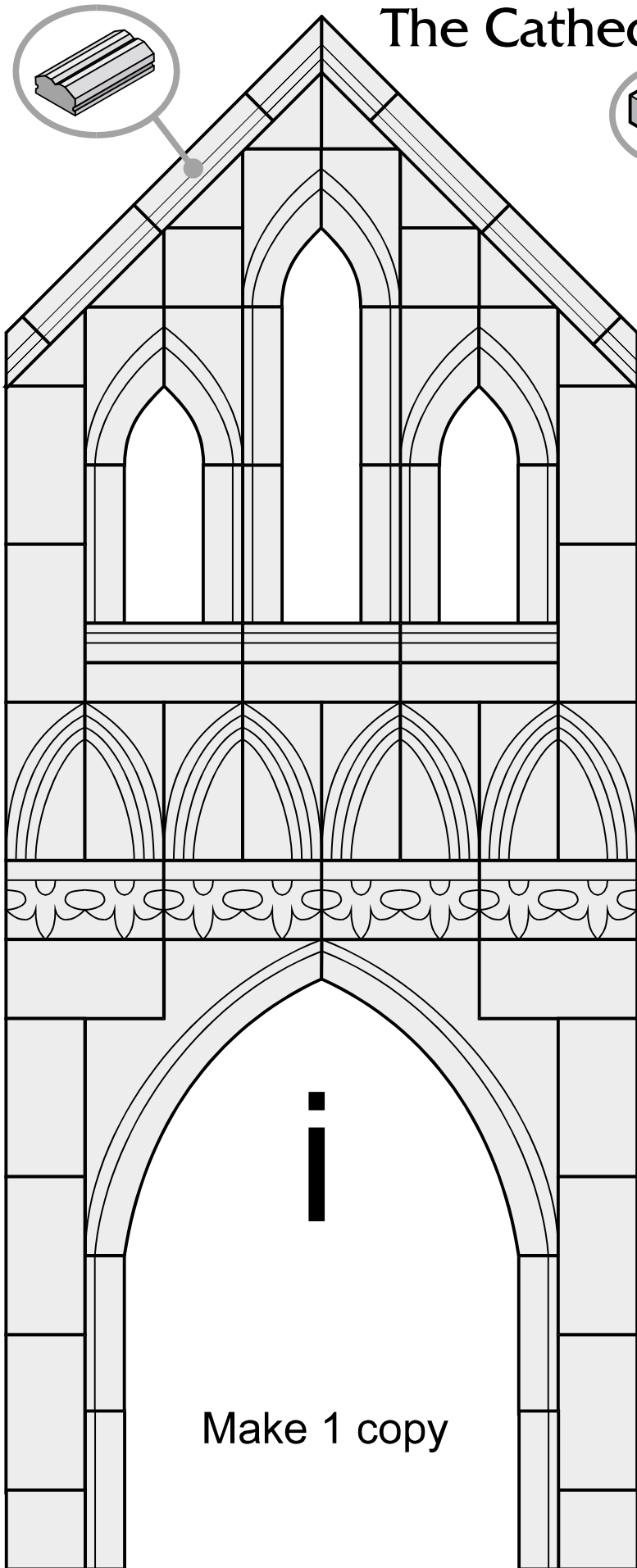

The Cathedral

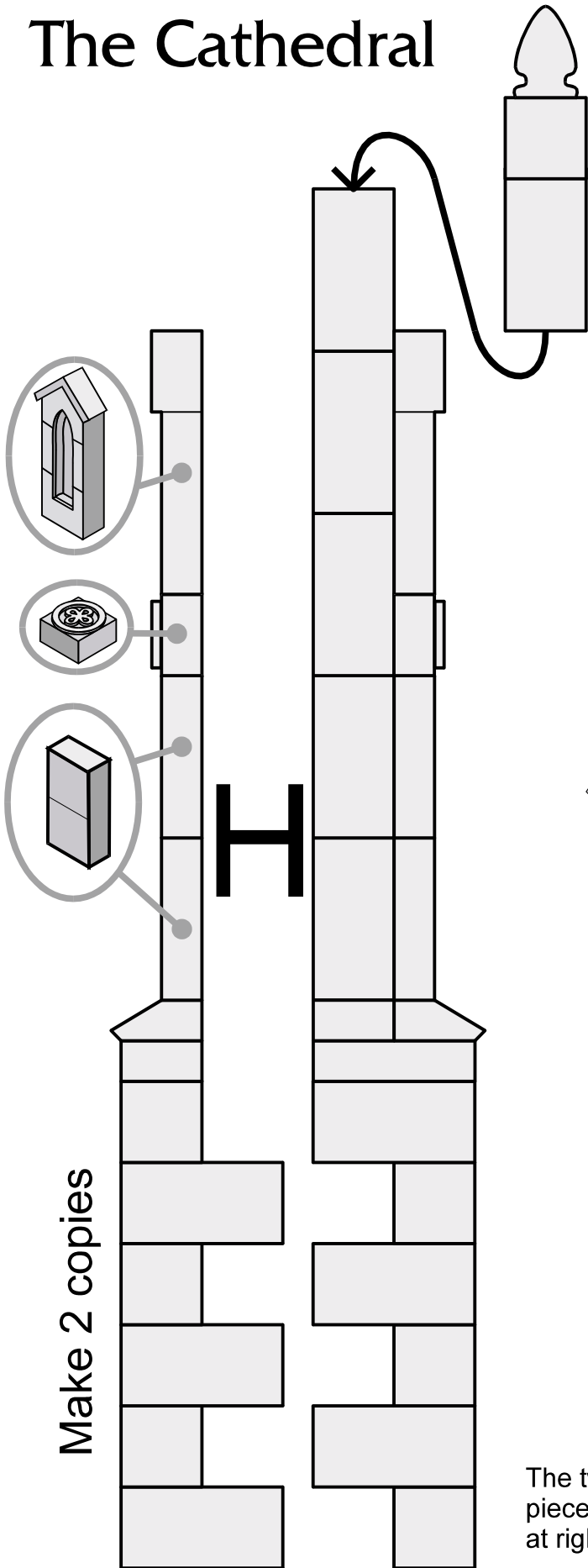

Make 2 copies

Make 2 copies

The two parts of this piece glue together at right angles.

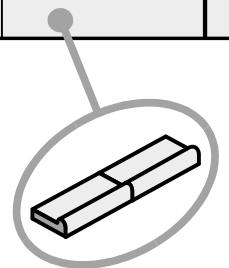
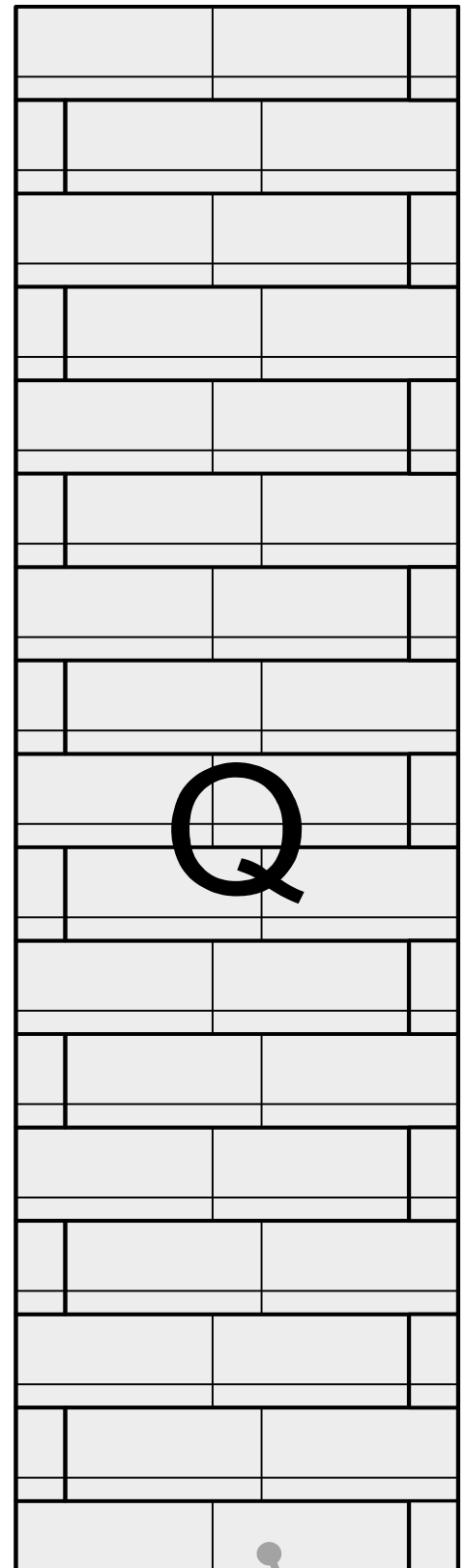

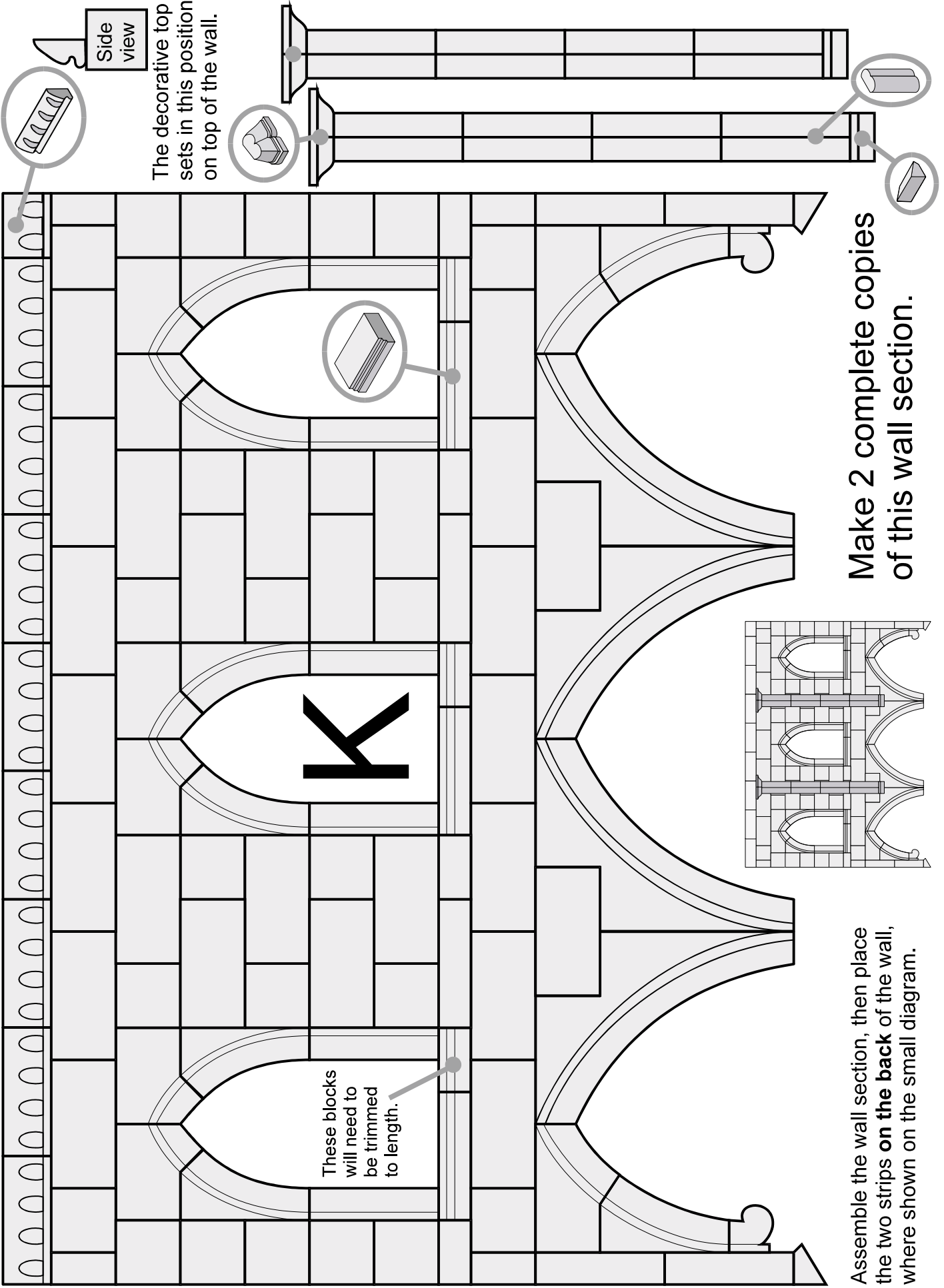

Side view

The decorative top sets in this position on top of the wall.

These blocks will need to be trimmed to length.

Make 2 complete copies of this wall section.

Assemble the wall section, then place the two strips **on the back** of the wall, where shown on the small diagram.

The Cathedral

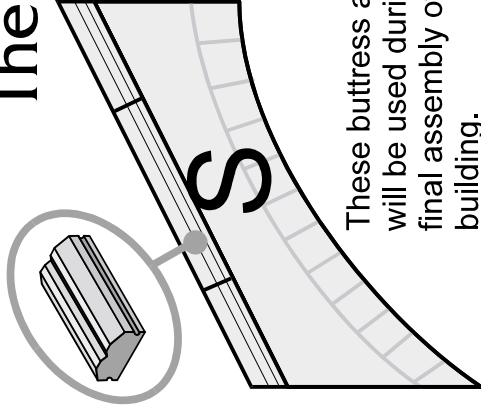

These buttress arches will be used during the final assembly of the building.

Make 4 copies

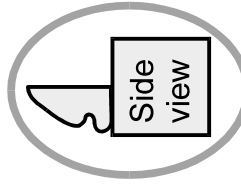

The decorative top sets in this position on top of the wall.

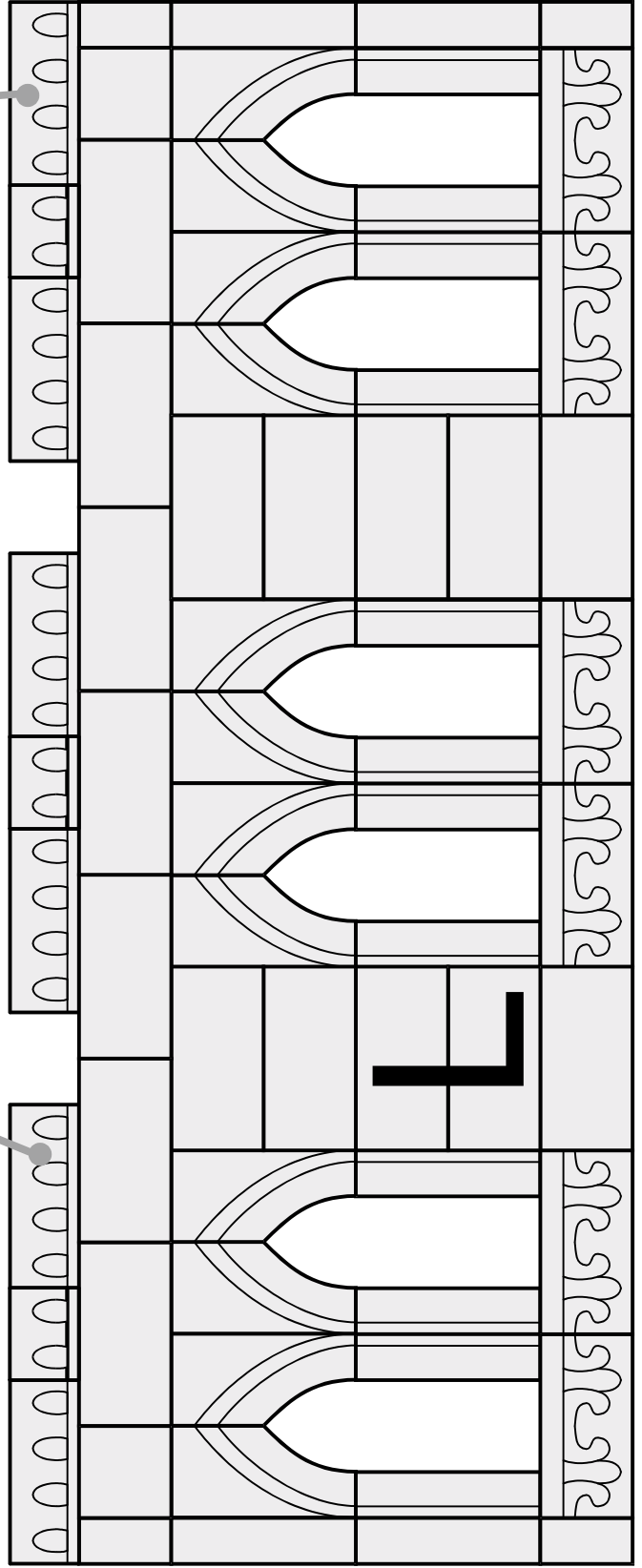

Make 2 copies

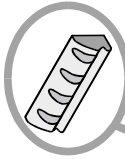

Trim this block with a hobby knife.

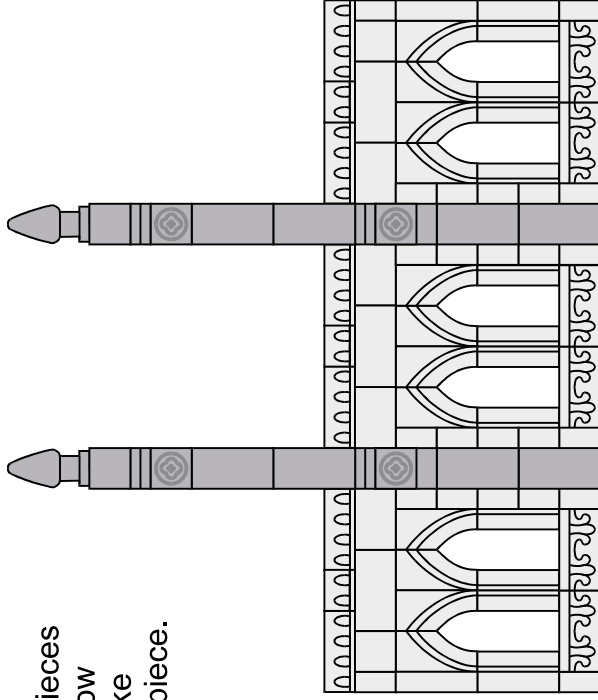

Glue the tall pieces onto the window section to make the complete piece.



Make 4 copies

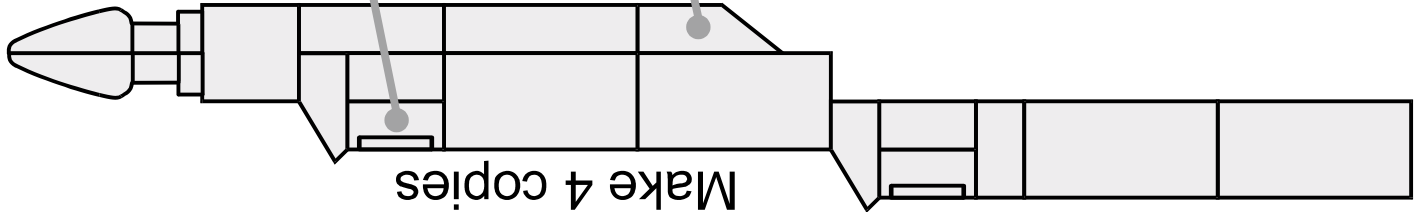

The Cathedral

Make one copy of the piece shown here, and one mirror image piece as well.

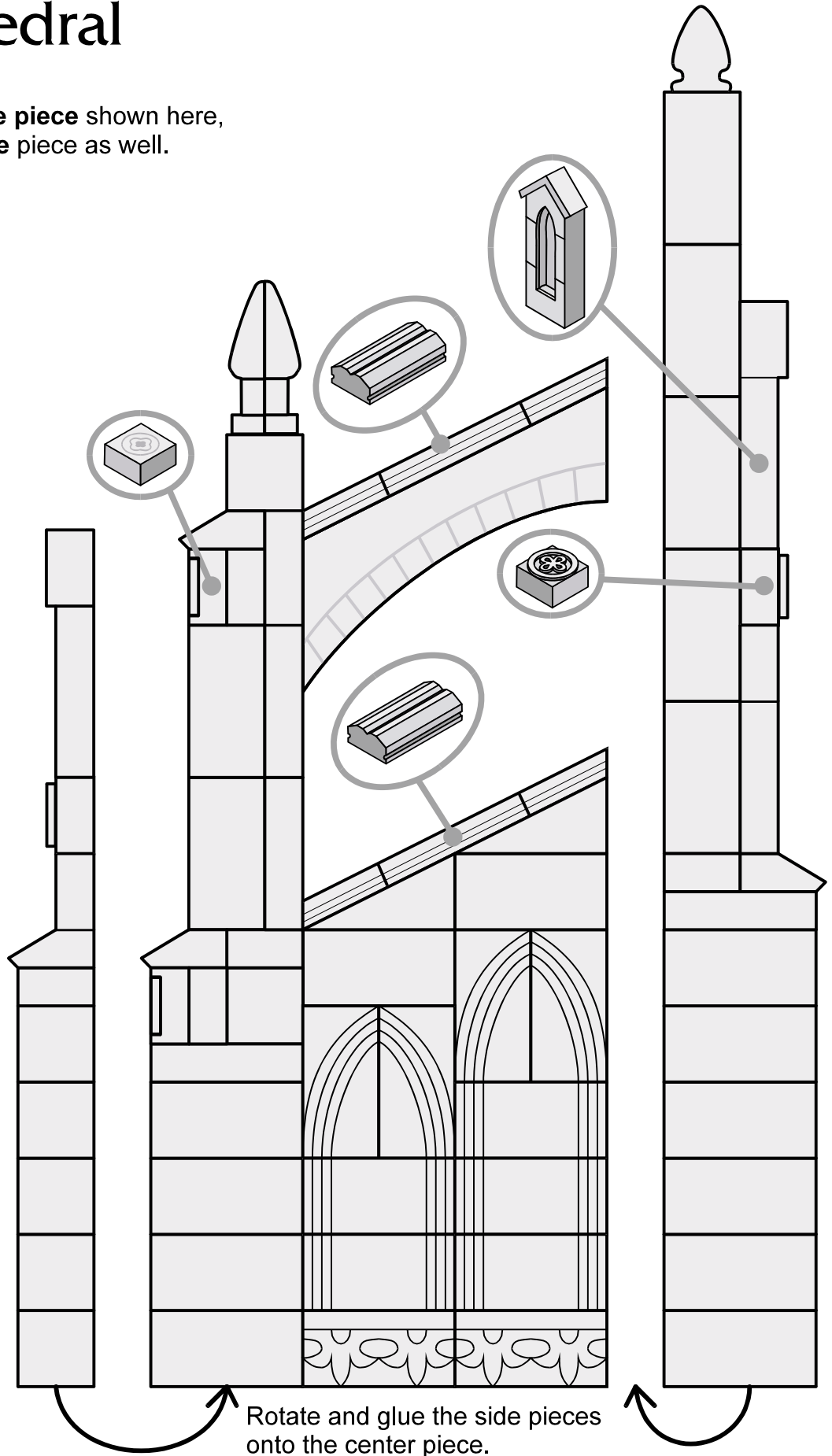
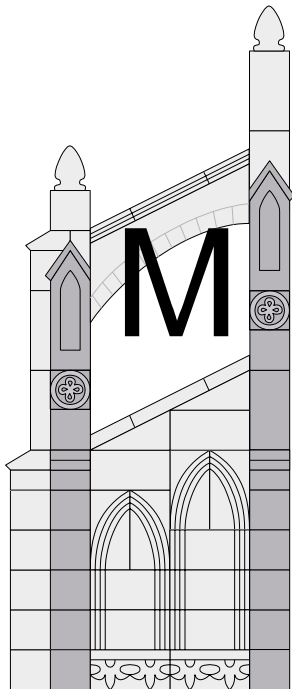
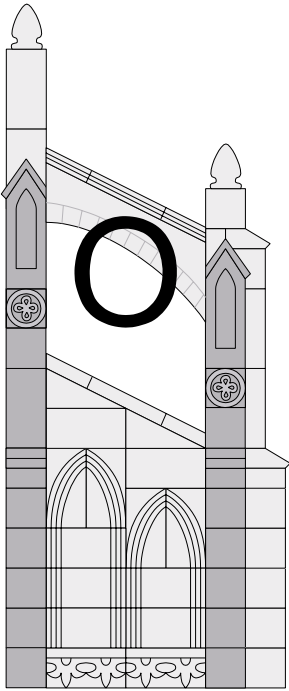

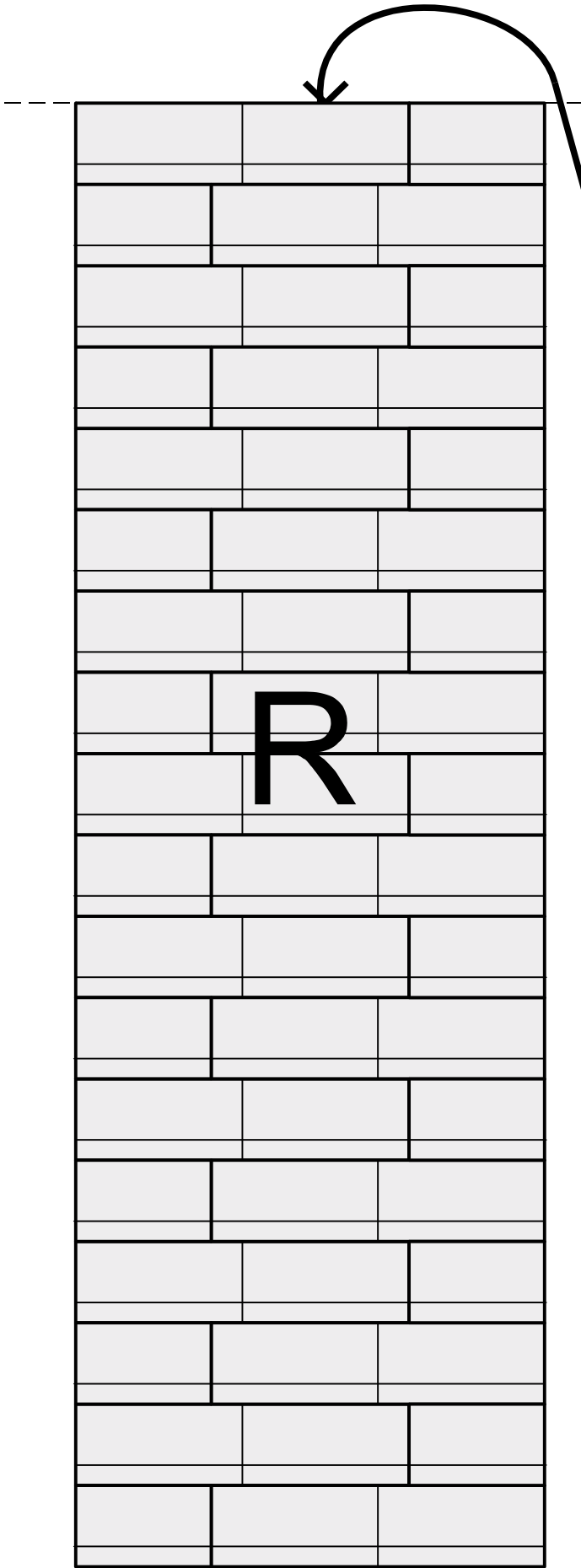

Splice this roof plan together before using.

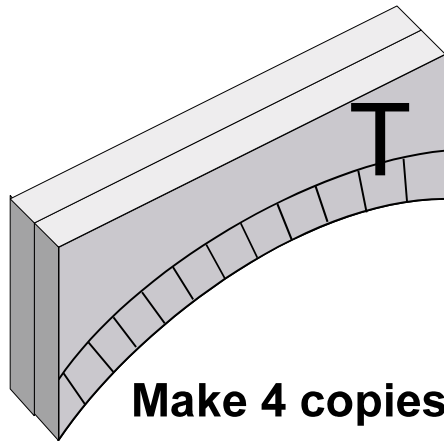
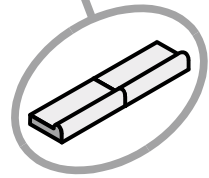
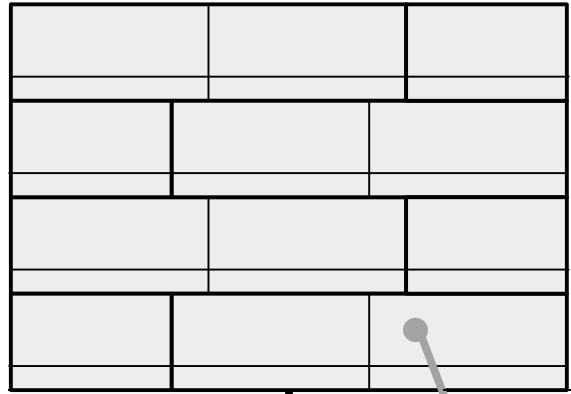

Make 4 copies

The Cathedral